

# INTUGRID HZE11

Zone Remote Control Panel

RevA

## Welcome

Thank you for choosing INTUSONIC for your sound system. To make sure that this product meets your expectations and provides long-term, reliable performance, please read and follow this instruction manual carefully.

## Manual language

- UK** This user manual is written in English. For other languages, please use an auto-translation service of your choice.
- FR** Ce guide est écrit en anglais. Pour les autres langues, veuillez utiliser un service de traduction automatique de votre choix.
- DE** Diese Anleitung ist in Englisch verfasst. Für andere Sprachen verwenden Sie bitte einen automatischen Übersetzungsdienst Ihrer Wahl.
- ES** Este manual está escrito en Inglés. Para otros idiomas, utilice un servicio de traducción automática de su elección.
- PT** Este manual está escrito em Inglês. Para outros idiomas, use um serviço de tradução automática de sua escolha.
- IT** Questo manuale è scritto in inglese. Per altre lingue, utilizza un servizio di traduzione automatica a tua scelta.

## Important safety instructions

- Read these instructions and all markings on the product. Keep these instructions.
- Heed all warnings and instructions, both in this manual and on the product.
- Clean only with a dry cloth. Unplug the unit or its power adaptor/charger from AC supply before cleaning.
- Do not use this product near water and avoid any exposure to water.
- Before connecting this product to any AC supply (if any), make sure to check whether the AC mains voltage and frequency match the indication on the product and its packaging.
- Only connect this product or its power adaptor/charger to an AC supply (if any) with sufficient power handling, protective earth connection, ground-fault (earth-fault) protection and overload protection.

- Disconnect the product or its power adaptor/charger from the AC supply (if any) during thunderstorms or longer periods of being unused.
- Make sure any heat sink or other cooling surface, or any air convection slot, is exposed sufficiently to free air circulation and is not blocked.
- Do not operate this product in environmental temperatures exceeding 35 degrees Celsius and/or 85% relative humidity.
- Position the product in a safe and stable place for operation, out of reach of unauthorized persons.
- Make sure any cable connections to and from the product are neither subject to potentially destructive mechanical impact nor present any risk of stumbling or other accident risk to people.
- Audio equipment may generate sound pressure levels sufficient to cause permanent hearing damage to persons. Always start up at low volume settings and avoid prolonged exposure to sound pressure levels exceeding 90dB.
- Do not open this product for service purposes. There are no user-serviceable parts inside.
- Warranty will be void in any case of unauthorized service by the user or other not authorized persons.
- Take any precaution required by local law, applicable regulations or good business practice to avoid injury of people or material damage by use of this product.

## Symbols used in this manual



**DANGER!** Safety hazard. Risk of injury or death.



**ATTENTION!** Read manual before installation and operation.



**WARNING!** Hazardous voltage. Risk of severe or fatal electric shock.



**WARNING!** Fire hazard.

## Health Advice

This unit may produce and absorb electromagnetic radiation. The strength of radiation and the sensitivity for disturbing interference matches the CE and FCC requirements. A corresponding sign is printed on the backside of the unit. Any change or modification may affect the behavior of the unit

concerning electromagnetic radiation, with the CE and FCC requirements eventually not to be met any more. The manufacturer takes no responsibility in this case.

### **Functional Advice (only for powered products)**

This unit is immune to the presence of electromagnetic disturbances – both conducted and radiated - up to a certain level. Under peak conditions, the unit is classified to show a “class C” performance criteria and may encounter temporary degradation or loss of function which may need manual help to recover. In such case, switch the unit off and back on to recover.

### **Environmental Advice**

This unit is built to conform to the ROHS-2 standard according to directive 2011/65/EU and the WEEE directive 2012/19/EU of the European Parliament and of the Council of the European Union. Under these regulations, the product shall not be discarded into regular garbage at the end of its life, but shall be returned to authorized recycling stations.

### **Battery Advice (only for battery-powered products)**

- Some products may contain a battery. Refer to the further chapters of this manual to determine whether this product contains a battery, and whether this is removable and/or rechargeable.
- Where applicable, adhere to the relative regulations in aviation transport.
- If the battery is rechargeable, the battery might not be fully charged or partly discharged at the time of purchase. Recharge before use. Only use recommended or included chargers with appropriate voltage/current rating.



**WARNING!** Fire hazard. Batteries might heat up during charging. Only charge in a place with sufficient air convection.

### **Wireless Advice**

- Some products may contain a wireless transmitter, receiver or transceiver. Refer to the further chapters of this manual to determine whether this product contains a wireless function, and in which frequency this operates.

- Make sure the frequency of operation does not require a specific license in the territory you operate the product in. If it does, obtain such license prior to any operation.
- Certain wireless technologies are designed for short distance operation. The actual distance will depend on how jammed the frequency band is at the location of use. In adverse cases, operational distances might be as low as 5m. In normal circumstances, 10m can be assumed. Test the operational distance prior to relying on the wireless functionality in a specific application.

## Unpacking

Please check that the box contains the following items:

- 1 pc. main unit
- 1 pc. alternative front panel
- 1 pc. user manual

If any part is missing, please contact your dealer immediately for replacement.

## Mounting options

The HZE11 is designed to fit standard wall boxes, but the variety of different wall box types across various countries requires an individual assessment of the best mounting way for a specific situation. The HZE11 is conceived with the following two wall box styles in mind:

- 80mm EU style square wall box, with 4 corner mounting holes
- 86mm UK style square wall box, with 2 center mounting holes

UK BS 5733  
86x86mm Box

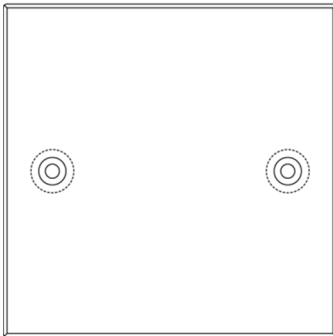

EU (VDE 0606-1)  
80x80mm Box

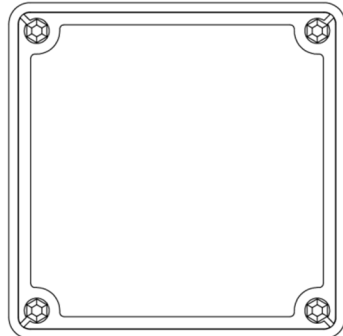

The ex-factory fitted panel is the UK-style panel. If the panel needs to be exchanged to the included EU-style replacement panel, follow the below procedure:

- Carefully pull off the volume control knob
- Loosen and remove the 4 rear-side screws which hold the PCB to the front panel.
- Carefully lift off the front panel.
- Fit the new front panel without applying any force. Make sure all switch caps and LED heads align with the apertures in the front panel.
- Re-fit the 4 mounting screws which hold the PCB to the front panel.
- Re-fit the volume control knob. Make sure to align the D-shaped cavity of the knob with the shaft of the rotary control.

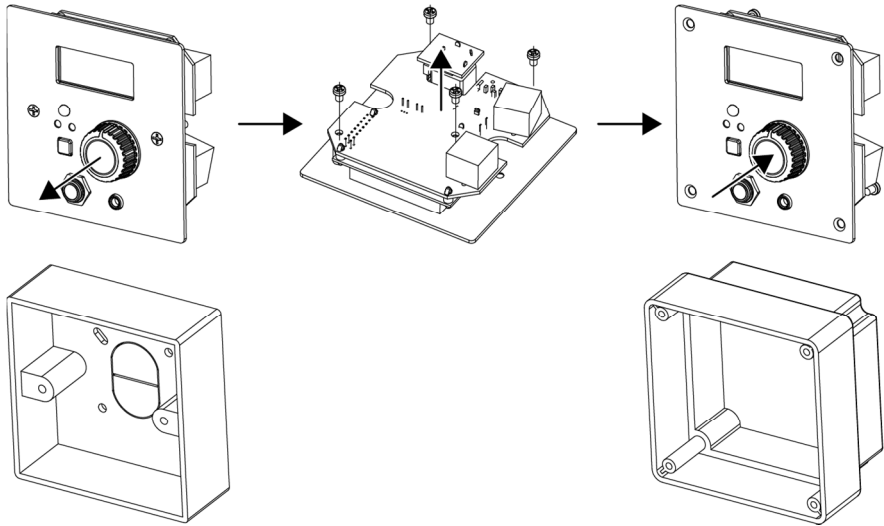

## About this product

The HZE11 is a wall-mounted remote control panel for compatible Intusonic products utilizing the Intulink™ bus. This wall remote control panel allows to remotely select a source, adjust the volume, observe the level setting and feed a local audio source to the controlled unit. The HZE11 is powered by the controlled unit through a single shielded CAT5/CAT6 cable.

## The Intulink™ bus system

The HZE11 uses Intusonic's Intulink™ control bus system, which uses standard CAT5/CAT6 shielded cables and combines RS485 control lines with power supply lines and a mono balanced audio connection according to the following pinout:

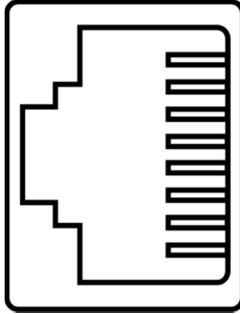

1. TXD/RXD-
2. TXD/RXD+
3. Not Connected
4. GND
5. Power +12V
6. Power -12V
7. Audio Mono Balanced +
8. Audio Mono Balanced -

A documentation of the RS485 commands used for remotely controlling devices with the Intulink™ bus system is continuously updated and hence only available for download from [www.intusonic.com](http://www.intusonic.com).



**WARNING!** Do not connect any other devices but Intusonic products with Intulink™ bus connection to the RJ45 ports of this unit. PC network connections or other manufacturer's RJ45-based interconnection systems are or may be incompatible, and the attempt of making such connection may result in damage of this unit or other equipment. The manufacturer accepts no claims towards damages evolving from incorrect connections.



**ATTENTION!** Do only use shielded CAT5/CAT6 cables with shielded connectors for better suppression of interference (EMI) in long cables runs.



**ATTENTION!** To make sure that your installation complies with EMC requirements, you must attach snap-on ferrites to both ends or at least one end (recommended close to the main unit) of the CAT5/CAT6 cable(s).

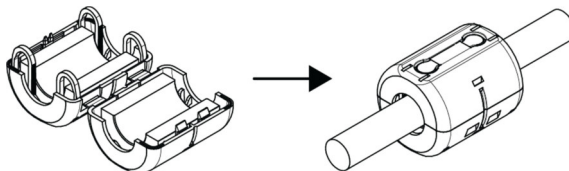

## Configuration (Software)

The HZE11 can be configured to meet certain operational requirements by making relative settings in its software EDIT mode. Note that settings are made for every zone separately, and require the HZE11 to be powered by a host product. Proceed as below:

- Make sure all subsequent equipment (amplifiers etc.) is switched off.
- Switch the host product on, so that the HZE11 is powered.
- Press the SRC (Source) button (3) for at least 3 seconds.
- The display (7) will show “EDIT?”, confirm by pressing the encoder (6). The Display (7) will show “>ZONE: X” with X being the currently assigned zone to this output.
- Select the desired zone by turning the encoder (6) and press the encoder once to confirm the choice. Note that the HZE11 must be set to the same zone setting than the main unit’s zone it is supposed to control. Also note that when controlling the HZE11 via the IR remote control (IRB44), the HZE11 will only be responsive to the IRB44 when the zone selector button on the IRB44 was pressed which mates the set zone in the HZE11, before any other commands.
- The display will now show “>IR: xxxxxxxx” with xxxxxxxx being either “enabled” or “disabled”. This will enable or disable the option to control this zone via the supplied IR remote control. Alter the setting if needed by turning the encoder (6) and press the encoder once to confirm the choice.
- The display will now show “>LCD ON: xxS” with xx being the time until the LCD backlight turns off automatically. Select a value between 5s and 60s by turning the encoder (6) and press the encoder once to confirm the choice.
- The display will now show “>SRC1: xxxxxxxx” with xxxxxxxx being a zone label which can be selected from a pre-stored list of labels. This setting allows to give SOURCE-1 a more expressive name which makes the use later easier for the operator. Instead of “SOURCE-1”, the source signal may e.g. be labelled “CD-1”. Select an entry from the list of available labels by turning the encoder (6) and press the encoder once to confirm the choice.
- The display will now show “>SRC2: xxxxxxxx” with xxxxxxxx being a zone label which can be selected from a pre-stored list of labels. The setting process is the same as for SRC1, and the process will now repeat for SRC3, SRC4, and SRC5.

- After setting the SRC5 label and pressing the encoder to confirm the selection, the display will show “settings updated” for about 5s and the unit will leave the EDIT mode and return to normal operational mode. The same happens if during any stage of the editing process, a period of more than 5s of inactivity occurs. Please note all changes made will be stored, regardless of whether the whole EDIT cycle was concluded or not.
- Note that the label for the local input (8)/(9) cannot be changed and is set fixed to LOCAL.
- The unit is now ready for operation. Turn the volumes down and switch on subsequent equipment.

## Controls and Connections

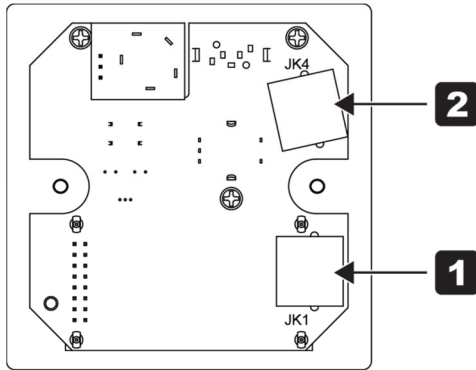

- 1** **Remote control output.** This is a RJ45 jack for the connection of other Intusonic devices featuring the Intulink™ bus system.
- 2** **Remote control loop-through.** This is a RJ45 jack for the connection of other Intusonic devices featuring the Intulink™ bus system.

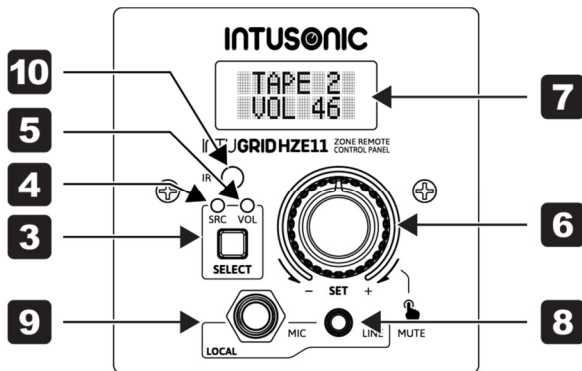

- 3** **Mode selector.** This switch selects the parameter adjusted by the encoder (6). The current selection is indicated by two LEDs, one to indicate that the volume adjustment is active (VOL – 5) and one to indicate that the source adjustment is active (SRC – 4). The default setting on powering up is VOL mode, and if the SRC mode was selected by this switch, after which the encoder (6) was turned and pressed to select and confirm a new source, the mode selector will return to VOL mode. Likewise, if the SRC mode was selected by this switch but no input is made via the encoder (6), the unit will return to VOL mode automatically after 5 seconds.

- 4 Source (SRC) mode indicator.** This green indicator lights up if the mode selector (3) is pressed, to indicate that now the source selector mode is active, and that a new source can be selected. The display (7) will show the word SELECT with a chevron (>) in front to indicate readiness for editing, and upon turning the encoder (6) will show the other available sources. Once a source was selected by pressing the encoder 6 for confirmation, this LED will turn off and the unit will return to VOL mode, indicated by the VOL mode indicator (5) being lit again.
- 5 Volume (VOL) mode indicator.** This green indicator lights up if the VOL mode is active, to indicate that the unit is in normal operational setting and the volume for the currently selected source can be adjusted via the encoder (6). If the encoder (6) is pressed while being in volume mode, the MUTE function will be activated and the volume mode indicator LED will turn from green to red; in addition, the percentage symbol shown for the currently selected volume will turn into the letter “M” in the display (7).
- 6 Encoder.** Turning the encoder will apply a volume change if the unit is in VOL mode, or a source change if the unit is in SRC mode. Note that volume changes become effective immediately; source changes require the encoder to be pressed once for confirmation. Pressing the encoder in VOL mode will invoke the MUTE function, indicated by the VOL mode indicator turning red and the percentage symbol in the display converting to “M”; pressing the encoder again then turns the VOL indicator back to green and calls back the prior volume setting.
- 7 Display.** This 2x8 digit backlit LCD display shows the current source and its volume setting in the 1<sup>st</sup> and 2<sup>nd</sup> line in VOL mode; and the word “>SELECT” in the 2<sup>nd</sup> line and the editable current source selection the 2<sup>nd</sup> line in SRC mode. The backlight will turn off automatically after a period of time editable in the configuration settings (see chapter configuration-software), and will turn on again after touching any of the controls (3) or (6).
- 8 Local audio line input.** This is a 3.5mm unbalanced TRS jack. Connect any local line-level source here. Note that while the jack accepts a stereo signal, the stereo signal will be summed to mono and will only become available as a source signal at the controlled unit in mono accordingly. If any microphone is connected to the local audio mic input (9) at the same time, the two signals will be mixed together in a 1:1 ratio. Press the mode selector switch (3) and turn the encoder (6) to select the “LOCAL” entry from the available sources, then press the encoder to confirm and make this the active source.

- 9** **Local audio microphone input.** This is a 6.35mm balanced TRS jack. Connect any local mic-level source here. If any line source is connected to the local audio line input (8) at the same time, the two signals will be mixed together in a 1:1 ratio. Press the mode selector switch (3) and turn the encoder (6) to select the “LOCAL” entry from the available sources, then press the encoder to confirm and make this the active source.
- 10** **IR sensor.** This optical sensor will receive the signals from an optional IRB44 infrared remote control, as long as there is a line of unobstructed sight between the unit and the infrared remote control. See any controlled unit’s user manual for instructions about the IRB44 infrared remote control.

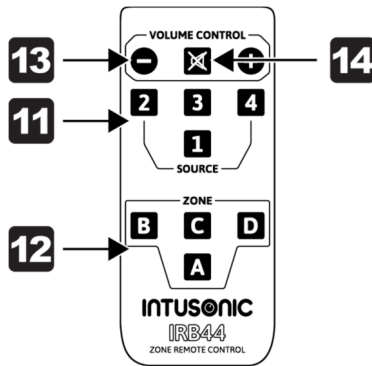

- 11** **IRB44 source selector switches.** Allow the remote control to directly select any of the first four inputs after selecting a receiving zone via the switches (12). The new input selection is shown in the display (7) of the respective zone.
- 12** **IRB44 zone selector switches.** These buttons allow to select the active receiving zone, as long as the IR remote is enabled in the EDIT menu of the HZE11. The HZE11 will only react to the IRB44 if the matching zone selector switch (2) has been pressed before.
- 13** **IRB44 Volume control (“-” and “+”).** Allow the remote control of the volume of the zone selected via the switches (12).
- 14** **IRB44 mute control.** Allows the remote control of the mute function of the zone selected via the switches (12). The volume mode indicator (5) will turn red to indicate the mute status, and the percentage symbol in the display (7) will convert to “M” for mute.

**Technical Data**

Power supply	.....±12V DC via Intulink™ bus
Dimensions WxDxH (/w knob)	.....86x86x42 mm
Panel mounting depth	.....30 mm
Weight	.....0.15 kg







## Warranty

This product is guaranteed to be free of defects in material and workmanship at the time of purchase. Send-in warranty repair is granted for a period determined by

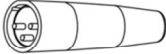
- A period of at least 6 months (from the date of purchase), or the minimum period required by law in the territory of sale, whichever is longer.
- A period of no longer (from the date of purchase) than the specified average lifetime of a component by the component's manufacturer.

## Cabling

This product may use all or a selection of the below connector types, for which the pin assignment must comply with the following specification. Always make sure to use good connectors and cables to ensure proper operation. Balanced connections are to be preferred over unbalanced connections where applicable and feasible. Avoid unbalanced connections exceeding 2m of cable length.

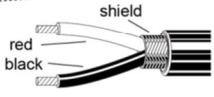
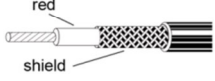
	Structure	Balanced connection	Unbalanced connection
<b>XLR male</b> 		red = 2 black = 3 shield = 1	red = 2 shield = 1+3
<b>XLR female</b> 		red = 2 black = 3 shield = 1	red = 2 shield = 1+3
<b>6.35mm TRS-stereo</b> 		red = tip black = ring shield = sleeve	red = tip shield = sleeve+ring
<b>6.35mm TRS-mono</b> 		red = tip black = sleeve shield = uncon.	red = tip shield = sleeve
<b>3.5mm TRS-stereo</b> 		red = tip black = ring shield = sleeve	red = tip shield = sleeve+ring
<b>RCA</b> 		red = tip black = sleeve shield = uncon.	red = tip shield = sleeve
<b>Terminal Plug</b> 		red = 1 black = 2 shield = 3	red = 1 shield = 2+3
<b>CABLE Types</b>	 <p>2-conductor shielded cable (for balanced connections)</p>	 <p>1-conductor shielded cable (for unbalanced connections)</p>	

**INTUSONIC**

INTUSONIC is a brand of  
Universal Technical Industries Co. Ltd.

**[www.intusonic.com](http://www.intusonic.com)**