



INTUFORCE 2SDL70

Stereo Audio Utility Amplifier

RevB

Welcome

Thank you for choosing INTUSONIC for your sound system. To make sure that this product meets your expectations and provides long-term, reliable performance, please read and follow this instruction manual carefully.

Manual language

- UK** This user manual is written in English. For other languages, please use an auto-translation service of your choice.
- FR** Ce guide est écrit en anglais. Pour les autres langues, veuillez utiliser un service de traduction automatique de votre choix.
- DE** Diese Anleitung ist in Englisch verfasst. Für andere Sprachen verwenden Sie bitte einen automatischen Übersetzungsdienst Ihrer Wahl.
- ES** Este manual está escrito en Inglés. Para otros idiomas, utilice un servicio de traducción automática de su elección.
- PT** Este manual está escrito em Inglês. Para outros idiomas, use um serviço de tradução automática de sua escolha.
- IT** Questo manuale è scritto in inglese. Per altre lingue, utilizza un servizio di traduzione automatica a tua scelta.

Important safety instructions

- Read these instructions and all markings on the product. Keep these instructions.
- Heed all warnings and instructions, both in this manual and on the product.
- Clean only with a dry cloth. Unplug the unit or its power adaptor/charger from AC supply before cleaning.
- Do not use this product near water and avoid any exposure to water.
- Before connecting this product to any AC supply (if any), make sure to check whether the AC mains voltage and frequency match the indication on the product and its packaging.
- Only connect this product or its power adaptor/charger to an AC supply (if any) with sufficient power handling, protective earth connection, ground-fault (earth-fault) protection and overload protection.

- Disconnect the product or its power adaptor/charger from the AC supply (if any) during thunderstorms or longer periods of being unused.
- Make sure any heat sink or other cooling surface, or any air convection slot, is exposed sufficiently to free air circulation and is not blocked.
- Do not operate this product in environmental temperatures exceeding 35 degrees Celsius and/or 85% relative humidity.
- Position the product in a safe and stable place for operation, out of reach of unauthorized persons.
- Make sure any cable connections to and from the product are neither subject to potentially destructive mechanical impact nor present any risk of stumbling or other accident risk to people.
- Audio equipment may generate sound pressure levels sufficient to cause permanent hearing damage to persons. Always start up at low volume settings and avoid prolonged exposure to sound pressure levels exceeding 90dB.
- Do not open this product for service purposes. There are no user-serviceable parts inside.
- Warranty will be void in any case of unauthorized service by the user or other not authorized persons.
- Take any precaution required by local law, applicable regulations or good business practice to avoid injury of people or material damage by use of this product.

Symbols used in this manual



DANGER! Safety hazard. Risk of injury or death.



ATTENTION! Read manual before installation and operation.



WARNING! Hazardous voltage. Risk of severe or fatal electric shock.



WARNING! Fire hazard.

Health Advice

This unit may produce and absorb electromagnetic radiation. The strength of radiation and the sensitivity for disturbing interference matches the CE and FCC requirements. A corresponding sign is printed on the backside of the unit. Any change or modification may affect the behavior of the unit

concerning electromagnetic radiation, with the CE and FCC requirements eventually not to be met any more. The manufacturer takes no responsibility in this case.

■ **Functional Advice (only for powered products)**

This unit is immune to the presence of electromagnetic disturbances – both conducted and radiated - up to a certain level. Under peak conditions, the unit is classified to show a “class C” performance criteria and may encounter temporary degradation or loss of function which may need manual help to recover. In such case, switch the unit off and back on to recover.

■ **Environmental Advice**

This unit is built to conform to the ROHS-2 standard according to directive 2011/65/EU and the WEEE directive 2012/19/EU of the European Parliament and of the Council of the European Union. Under these regulations, the product shall not be discarded into regular garbage at the end of its life, but shall be returned to authorized recycling stations.

■ **Battery Advice (only for battery-powered products)**

- Some products may contain a battery. Refer to the further chapters of this manual to determine whether this product contains a battery, and whether this is removable and/or rechargeable.
- Where applicable, adhere to the relative regulations in aviation transport.
- If the battery is rechargeable, the battery might not be fully charged or partly discharged at the time of purchase. Recharge before use. Only use recommended or included chargers with appropriate voltage/current rating.



WARNING! Fire hazard. Batteries might heat up during charging. Only charge in a place with sufficient air convection.

■ **Wireless Advice**

- Some products may contain a wireless transmitter, receiver or transceiver. Refer to the further chapters of this manual to determine whether this product contains a wireless function, and in which frequency this operates.

- Make sure the frequency of operation does not require a specific license in the territory you operate the product in. If it does, obtain such license prior to any operation.
- Certain wireless technologies are designed for short distance operation. The actual distance will depend on how jammed the frequency band is at the location of use. In adverse cases, operational distances might be as low as 5m. In normal circumstances, 10m can be assumed. Test the operational distance prior to relying on the wireless functionality in a specific application.

Unpacking

Please check that the box contains the following items:

- 1 pc. main unit (with mounted TPR bumper corners)
- 1 pc. AC cord set
- 1 pc. instruction manual
- 1 pc. bracket set (2xfront bracket, 4xsurface bracket)

If any part is missing, please contact your dealer immediately for replacement.



WARNING! After unpacking, and before plugging the AC cord in the wall outlet, check whether the AC mains voltage and frequency is the same as this product is specified for (see rear panel of product). Whenever the specified voltage or your AC plug should not match the local conditions, do NOT plug the AC cord into the wall outlet and contact your dealer immediately.

AC Mains Voltage Setting

If the AC mains voltage of your power outlet and the setting of the AC supply voltage on your unit do not match, contact your dealer, contractor or a qualified service workshop to change the setting of the AC voltage selector. The AC voltage selector switch is located on the side panel of the unit, close to the AC inlet.

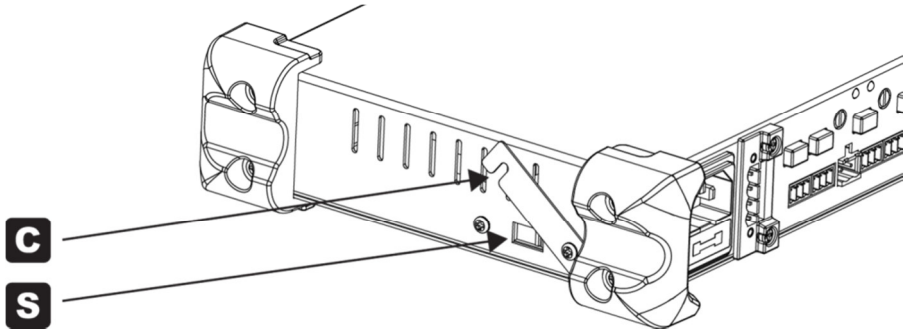

For a qualified technician to change the AC voltage setting, the AC cord shall be detached, the security cover (C) shall be flipped up, and the Voltage selector switch (S) shall be set to the new position. Afterwards, the security cover (C) shall be set back into a protective position to avoid tampering with the switch.

Panel/Surface Mounting

This product comes pre-assembled with synthetic rubber (TPR) corner bumpers. Depending on the installation, it might be commendable to replace these bumpers either with panel brackets or surface brackets, both included with the product; or the unit can be mounted in the optional JUP-2 rack bracket (option C). Follow the illustration, remove the TPR bumpers (steps 1-2-3) and re-assemble as follows:

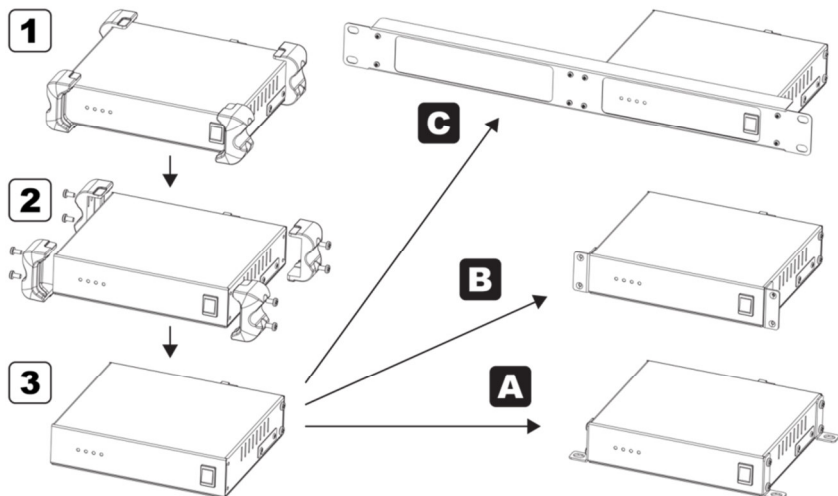

About this product

The 2SDL70 is a versatile low-impedance audio amplifier for installation purposes. It sports most of its controls on the rear panel to avoid any unnecessary user interaction. Input forwarding allow stereo and mono operation in a very simple manner, and the filter and level setting options per channel allow this unit to be configured for any size and complexity of sound systems. Silent, fan-less convection cooling enables low noise emissions and excellent reliability.

Controls and Connections

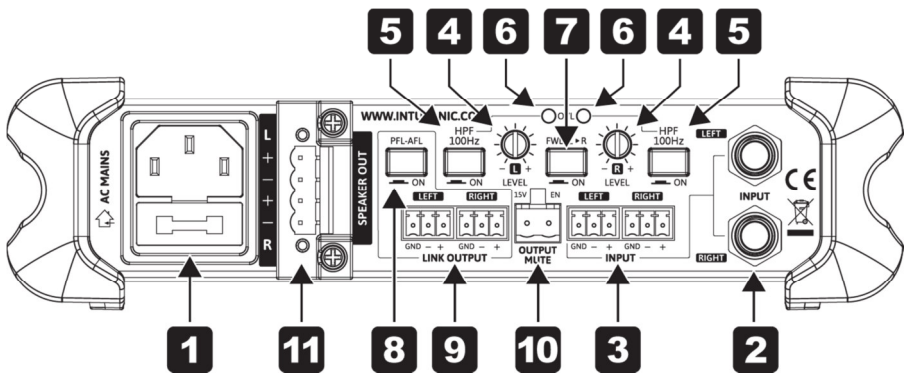

- 1 AC inlet and fuse holder.** Use the supplied AC cord to connect the unit to AC mains. Make sure voltage and frequency stated and set on the unit comply with your local AC supply. The fuse can be accessed by the small drawer at the AC inlet. To change the fuse, unplug the AC cord first, pull out the fuse drawer and replace the fuse ONLY with a fuse of SAME voltage and rating. If the fuse blows again after replacement, hand over the unit to qualified service personnel.
- 2 Left and Right Input.** These are balanced TRS connectors which accept line level input signals. These connectors are in parallel with the Dual terminal strip inputs (3).
- 3 Left and Right Inputs.** These are balanced 3.5mm terminal strip inputs which accept line level input signals. These connectors are in parallel with the TRS inputs (2).



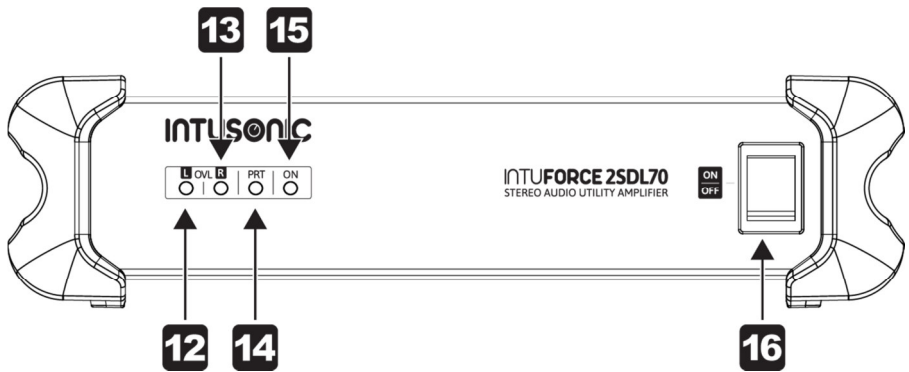







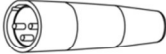
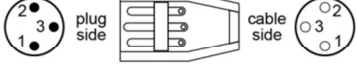

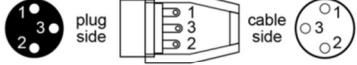
- 4 Channel level controls.** These controls allow to set the input sensitivity levels of the channels L and R independently. Make sure that even at peak input signal conditions, this control is set to avoid the OVL indicator (6) to be lit more than occasionally. Adjustments shall be made with a small screw driver. Note that the total angle is 300 degrees; do not apply excessive force with the screw driver.
- 5 High Pass Filter Switches.** Pressing these switches will engage an 18dB/Oct. HPF at 100Hz. This is recommendable when the respective amplifier channel feeds a smaller speaker which is incapable of reproducing very low frequencies. Engaging this switch will protect the speaker from harmful low-frequency input energy.
- 6 Input overload indicators.** These LEDs will light up at +4dBu, and help to find a maximum allowed setting for the channel level controls (4). Make sure that this indicator is only occasionally lit even under peak input signal conditions.
- 7 Forward L to R switch.** This switch allows the signal at the input L input terminal (2/3) to be internally forwarded to right input terminals without any further external cabling. Once this switch is pressed, any signals connected to the right input terminals will be ignored. All other controls (4 / 5 / 6) remain to operate independently.
- 8 Link Output Routing Switch.** When this switch is un-pressed, the Link output (9) carries the unaltered input signal from the left and right inputs (2/3). This will allow a further amplifier to use the same signals, but with its own level settings. When this switch engaged, the link output routing will be changed to a point after the level settings. This will allow a further amplifier to follow the level settings of the prior amplifier in the chain.
- 9 Link Outputs.** These are balanced 3.5mm terminal strip outputs which carry the same signal as the left input (2 / 3). Depending on the setting of the Link Routing switch (8) the signal at this link output is either taken straight from the input (2 / 3) or only after being processed by the relative channel's level and filter controls (4 / 5).
- 10 Music Mute input.** This is a terminal block input which allows to remotely mute the speaker output (11) by simply shortening the contacts.
- 11 Speaker Output.** This is a 4-pole 5mm pitch terminal strip connector. Connect the speakers here. Note:
 - ▶ Minimum total load impedance is 4 Ohms.
 - ▶ This amplifier has no bridge output provision. Do not attempt any cross-connection between the output channels.

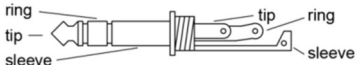

- 12 Left Overload Indicator.** This indicator signals the input signal exceeding the recommendable level, and shall only be occasionally flashing. In case this indicator is invoked frequently, reduce the input sensitivity setting via the rear controls (4) to avoid distortion.
- 13 Right Overload Indicator.** This indicator signals the input signal exceeding the recommendable level, and shall only be occasionally flashing. In case this indicator is invoked frequently, reduce the input sensitivity setting via the rear controls (4) to avoid distortion.
- 14 Protection Indicator.** This indicator signals the amplifier's protection circuitry being tripped. This might be caused by over-temperature, overcurrent, DC voltage or a short circuit at the output and may be accompanied with a temporary shutdown of the amplifier until safe operating conditions are restored. If this indicator does not turn off, the unit may need servicing.
- 15 Power Indicator.** This indicator signals the on (lit) and off (not lit) status.
- 16 Power switch.** Switches the unit on and off. Make sure to switch the unit off when not in use. The ON position is indicated by the lit Power indicator (15).

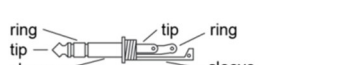
Signal Cabling

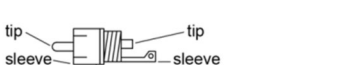
This product may use all or a selection of the below connector types, for which the pin assignment must comply with the following specification. Always make sure to use good connectors and cables to ensure proper operation. Balanced connections are to be preferred over unbalanced connections where applicable and feasible. Avoid unbalanced connections exceeding 2m of cable length.

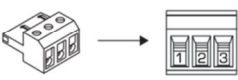
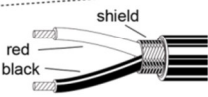
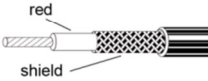
| | Structure | | Balanced connection | Unbalanced connection |
|--------------------------|---|---|--|-----------------------------------|
| XLR male |  |  | red = 2 black = 3 shield = 1 | red = 2 shield = 1+3 |
| XLR female |  |  | red = 2 black = 3 shield = 1 | red = 2 shield = 1+3 |
| 6.35mm TRS-stereo |  |  | red = tip black = ring shield = sleeve | red = tip shield = sleeve+ring |
| 6.35mm TRS-mono |  |  | red = tip black = sleeve shield = uncon. | red = tip shield = sleeve |
| 3.5mm TRS-stereo |  |  | red = tip black = ring shield = sleeve | red = tip shield = sleeve+ring |
| RCA |  |  | red = tip black = sleeve shield = uncon. | red = tip shield = sleeve |
| Terminal Plug |  |  | red = 1 black = 2 shield = 3 | red = 1 shield = 2+3 |
| CABLE Types |  2-conductor shielded cable (for balanced connections) | |  1-conductor shielded cable (for unbalanced connections) | |

Speaker Cabling

Aside of proper signal cabling for the input signals, the choice of suitable speaker cables is often a neglected but at the same time essential point of amplifier installation. Speaker cables, specifically long ones, can significantly contribute to the load impedance of the amplifier, thus reducing the power output and turning some of the output power into heat instead of delivering it to the speakers. The most important aspect is to keep cables as short as possible and to choose a sufficient copper cross-section, with maximum length values as per below.

| Cross-Section | 0.75mm ² | 1.50mm ² | 2.50mm ² | 4.00mm ² |
|----------------------|---------------------|---------------------|---------------------|---------------------|
| AWG | 18 | 15 | 13 | 11 |
| Ω per m | 0.0224 | 0.0112 | 0.00672 | 0.00472 |
| 2Ω load | 4.00m | 8.00m | 12.00m | 16.00m |
| 4Ω load | 8.00m | 16.00m | 24.00m | 32.00m |
| 6Ω load | 15.00m | 30.00m | 45.00m | 60.00m |
| 8Ω load | 22.50m | 45.00m | 60.00m | 90.00m |

Note: 2 Ω loads are only listed for reference but not applicable to this product.

Block diagram

Technical Data

| | |
|-----------------------------|-----------------------------------|
| Rated Power @ 4Ω/8Ω |2x65W/35W |
| Frequency response |20H-20kHz (+-0.5dB) |
| S/N ratio (8Ω, full power) |> 88dB |
| Residual Noise (full power) |< -62dBu |
| Crosstalk Damping |> 66dB |
| THD&N (rated power) |<0.08% |
| AC IN |115/230V~, 50/60Hz, max 160W |
| Dimensions WxDxH (bare) |180x150x42 mm |
| Dimensions WxDxH (corners) |205x181x53 mm |
| Weight |1.22 kg |

Warranty

This product is guaranteed to be free of defects in material and workmanship at the time of purchase. Send-in warranty repair is granted for a period determined by

- A period of at least 6 months (from the date of purchase), or the minimum period required by law in the territory of sale, whichever is longer.
- A period of no longer (from the date of purchase) than the specified average lifetime of a component by the component's manufacturer.

INTUSONIC

INTUSONIC is a brand of
Universal Technical Industries Co. Ltd.

www.intusonic.com